



AC Circuit Theory



Prepared by Bill Hardy, TESCO

*For North Carolina Electric Meter School
Tuesday, June 27, 2017 at 1:00 p.m.*



A Little History

- **1800** Volta
 - First electric battery
- **1830-31** Faraday and Henry
 - Changing magnetic field can induce an electric current. Build first very crude electric motors in lab.
- **1832** Pixii
 - First crude generation of an AC current.
- **1856** Siemens
 - First really practical electric motor
- **1860s** Varley, Siemens and Wheatstone
 - Each develop electric dynamos (DC Generators).



A Little History

- **1870s**
 - First electric railroad and street lights in Berlin (DC).
- **1880**
 - First electric elevator (DC).
- **1885-88 Thomson, Ferraris, Tesla**
 - Each develop AC electric induction motors.
 - Tesla is granted a US patent for induction motor in 1888.
- **1890 Dolivo-Dobrovolsky**
 - First three phase generator, motor and transformer



A Little History

- Edison and Westinghouse
 - Edison favored DC power distribution, Westinghouse championed AC distribution.
 - The first US commercial electric systems were Edison's DC systems.
- First AC system was in 1893 in Redlands, CA. Developed by Almirian Decker it used 10,000 volt, three phase primary distribution.
- Siemens, Gauland and Steinmetz were other pioneers.



War of the Currents

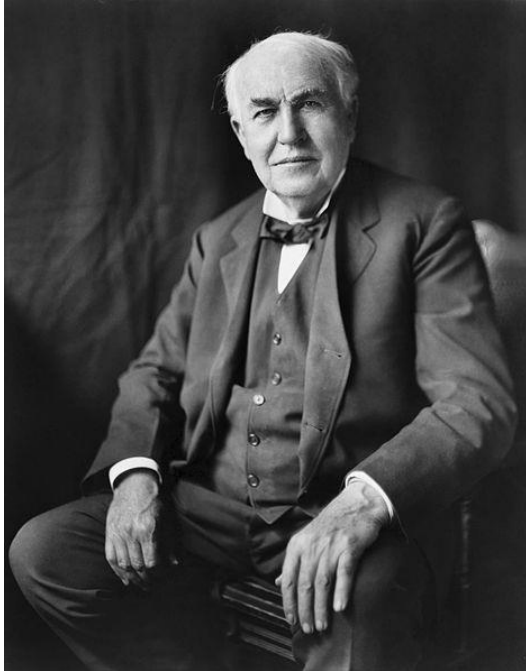

Thomas Edison

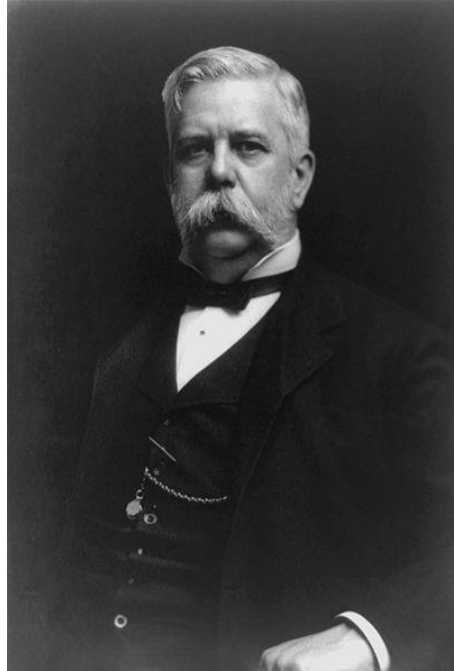

George Westinghouse

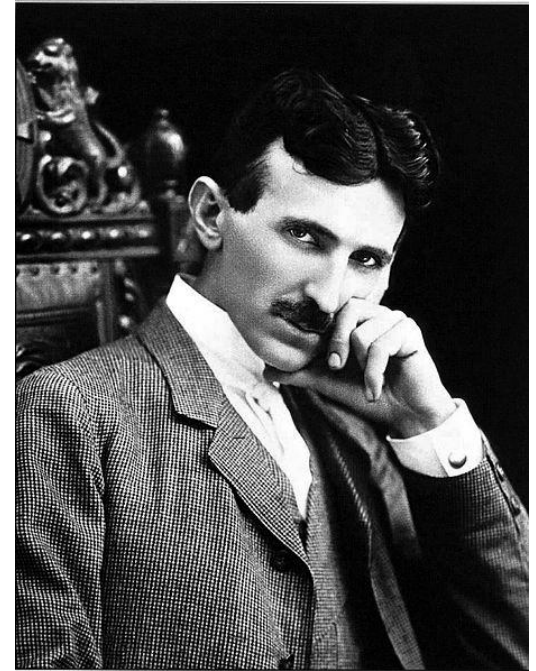

Nikola Tesla



AC Theory - History

- By 1900 AC power systems had won the battle for power distribution.
 - Transformers allowed more efficient distribution of power over large areas.
 - AC motors were cheaper and easier to build.
 - AC electric generators were easier to build.



AC vs DC

- **Direct Current (DC)** – an electric current that flows in one direction.(IEEE100)
- **Alternating Current (AC)** – an electric current that reverses direction at regularly recurring intervals of time. (IEEE100)



AC Circuits

- An AC circuit has three general characteristics
 - Value
 - Frequency
 - Phase
- In the US, the household value is 120 Volts with other common voltages being 208, 240, 277 and 480 Volts. The frequency is 60 Hertz (cycles per second).



AC Theory – Sine Wave

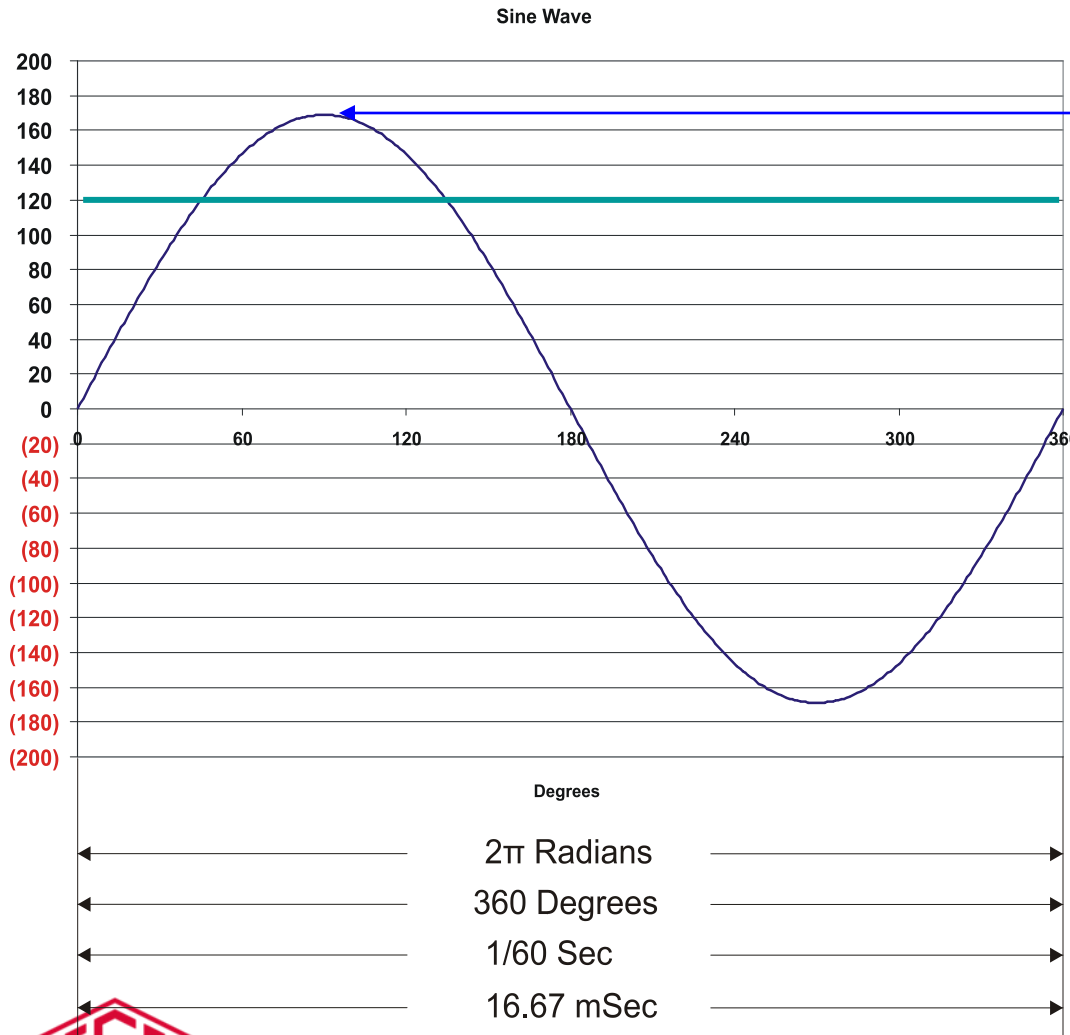

$$V = V_{pk} \sin(2\pi ft - \theta)$$

$$V = \sqrt{2} V_{rms} \sin(2\pi ft - \theta)$$

$$V_{rms} = 120$$

$$V_{pk} = 169$$

$$\theta = 0$$

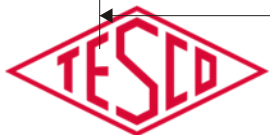

AC Theory - Phase

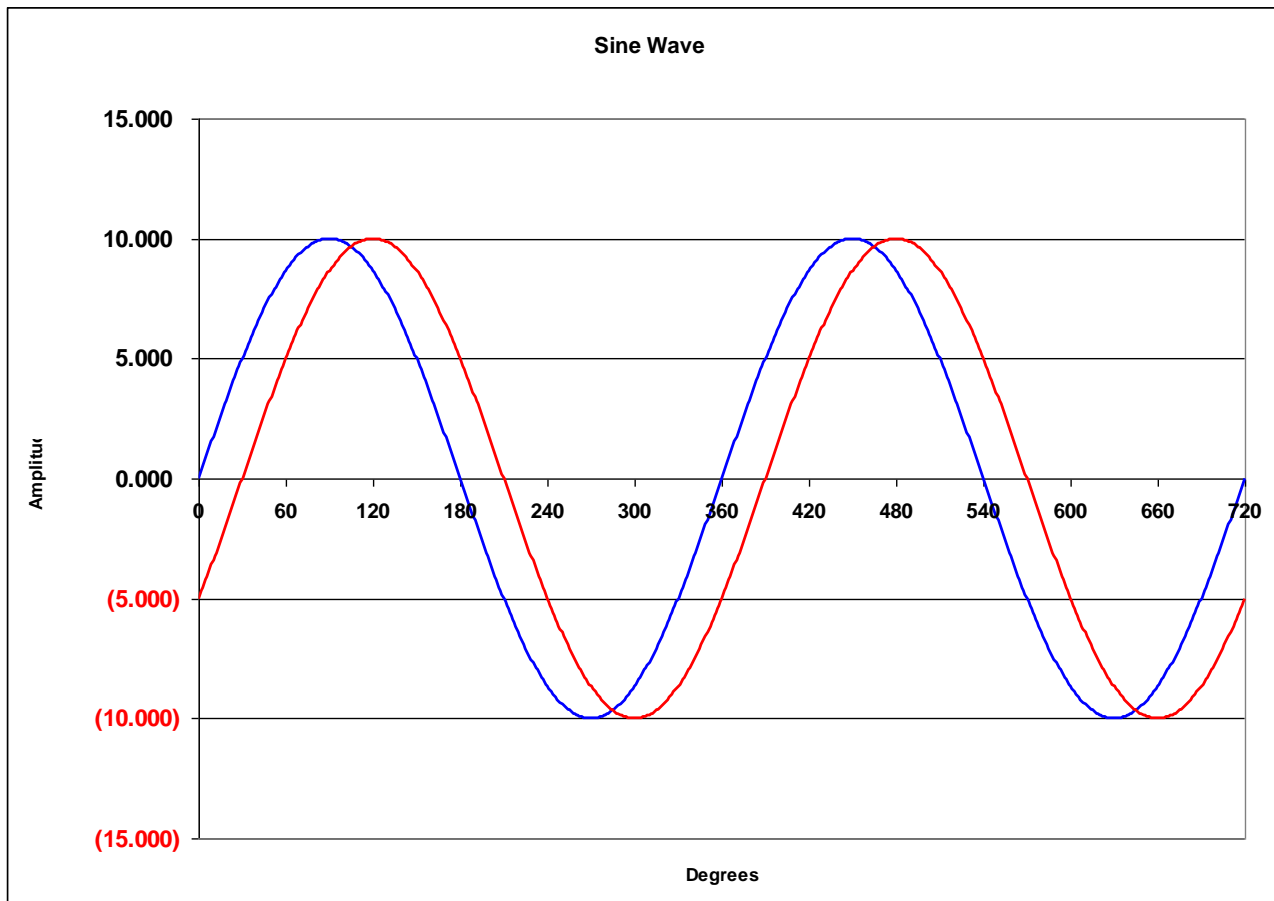

$$V = 10\sin(2\pi ft)$$

$$I = 10\sin(2\pi ft - 30)$$

Here current LAGS voltage.



AC vs DC

- In DC theory we learned
 - Ohm's Law
 - **Voltage = Current x Resistance**
 - **$V = IR$**
 - Power
 - **$P = I^2R = V^2/R$**
- For AC we would like the same equations to apply.
 - Specifically we want to be able to say that a DC voltage of 10 Volts applied to a resistor of value R produces the same power dissipation as an AC voltage of 10 volts applied to the same resistor.



AC Theory – RMS

- For DC voltage to equal AC voltage we need

$$\frac{V_{dc}^2}{R} = \int \frac{1}{R} V_0^2 \sin^2(2\pi ft - \theta) dt$$

$$\frac{V_{dc}^2}{R} = \frac{V_0^2}{2R}$$

$$V_0 = \sqrt{2} V_{DC}$$



AC Theory - RMS

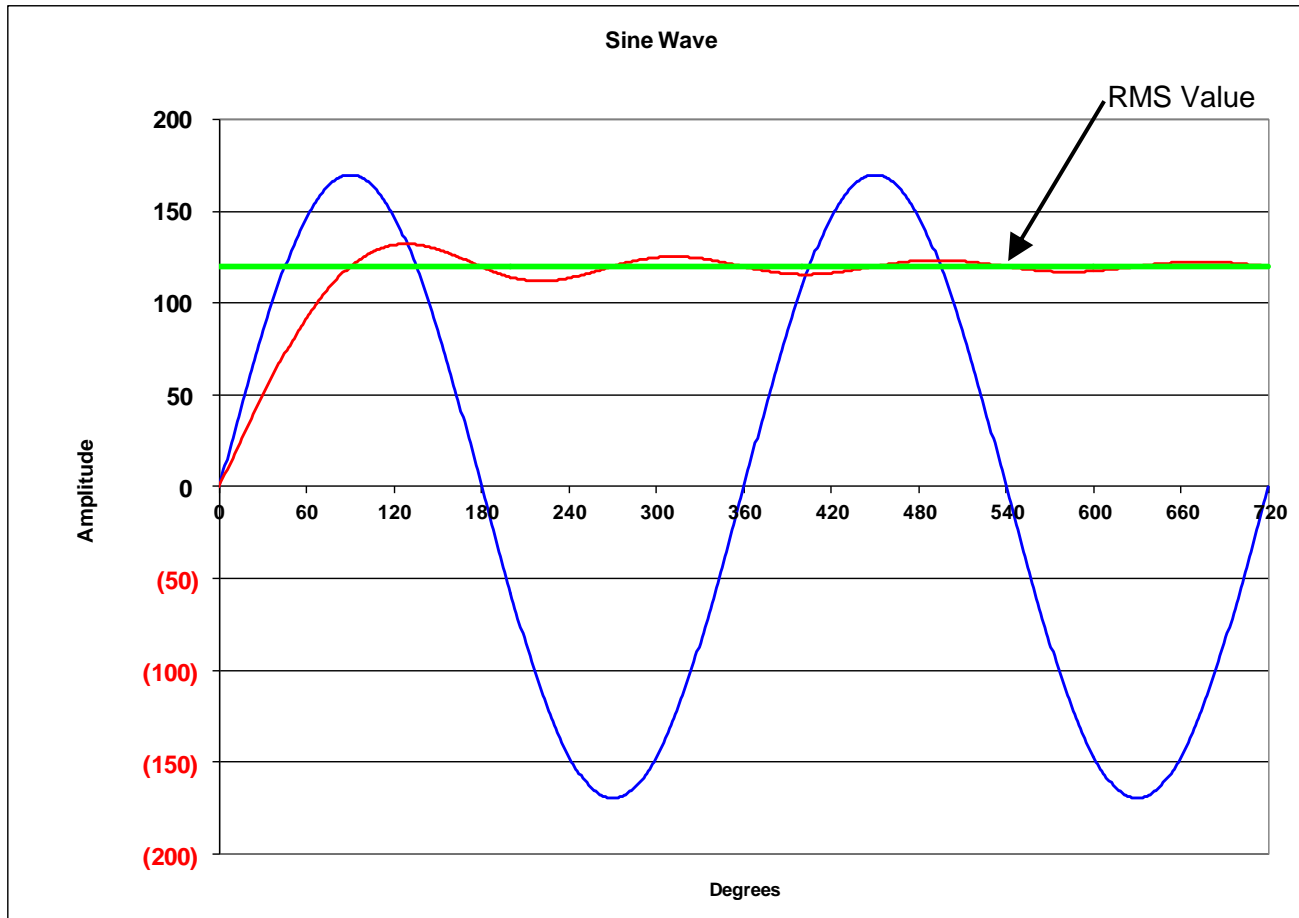

$$V = 120\sqrt{2} \sin(\omega t) = 169.68 \sin(\omega t)$$



AC Theory – RMS

- So if we want to have the V in our equation for an AC signal represent the same value as the its DC counterpart we have

$$V(t) = \sqrt{2}V_{DC} \sin(2\pi ft - \theta)$$

- By convention in AC theory we refer to V_{DC} as the RMS (Root Mean Squared) voltage.
- When we talk about AC values we always mean the RMS value not the peak value unless we say so specifically



AC vs DC

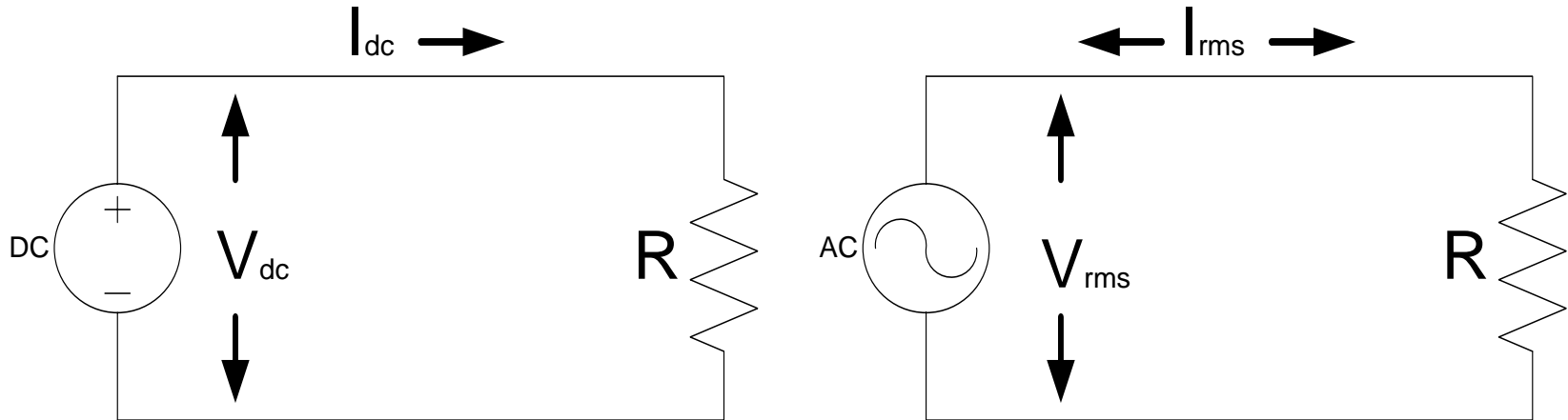

$$V = IR$$

$$P = VI = I^2R = V^2/R$$



AC Theory – Resistive Load

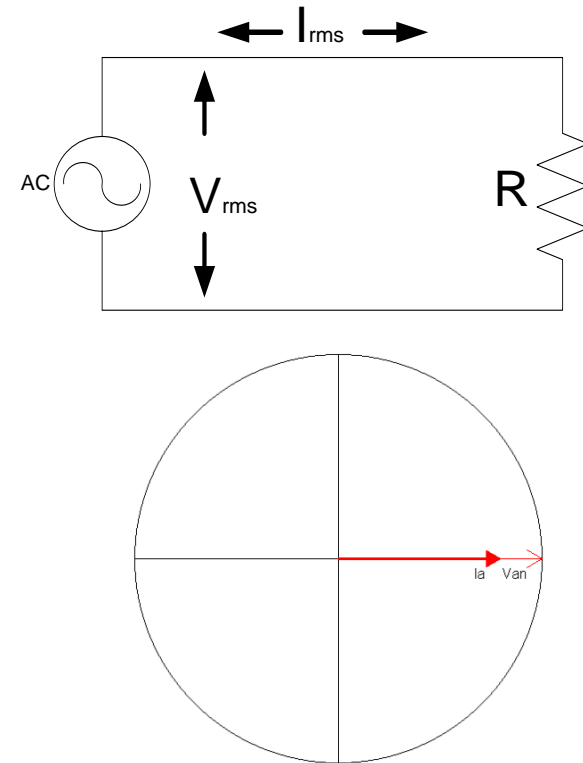
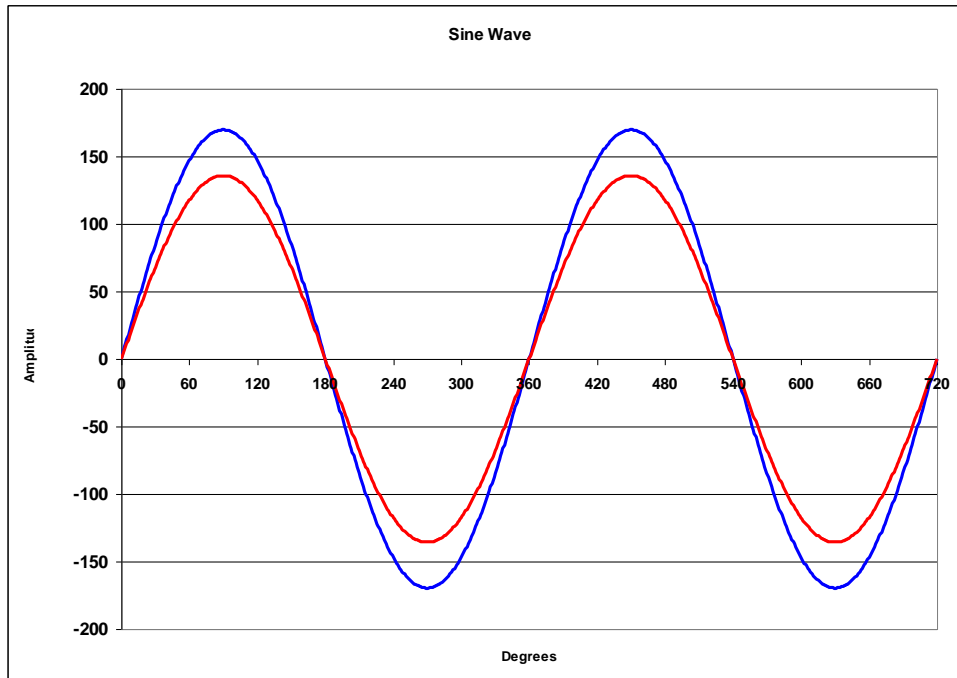

Resistors are measured in Ohms. When an AC voltage is applied to a resistor, the current is in degrees. A resistive load is considered a “linear” load because when the voltage is sinusoidal the current is sinusoidal.



AC Theory – Inductive Load

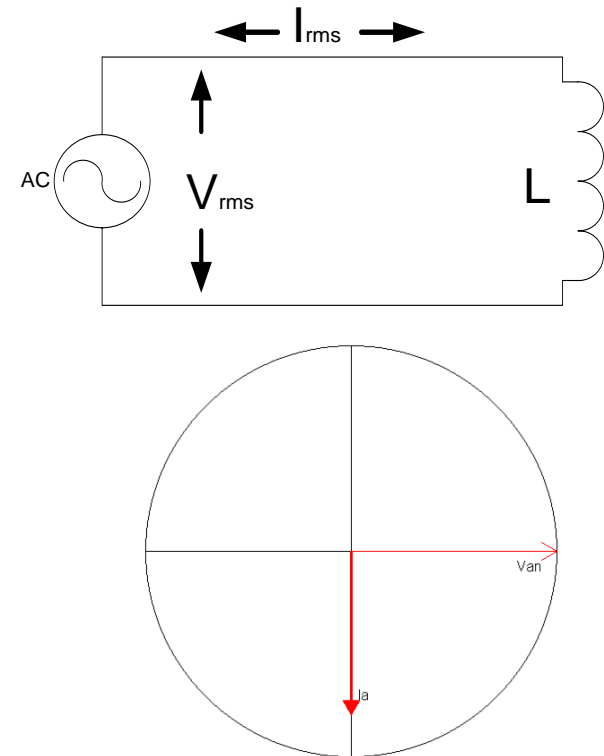
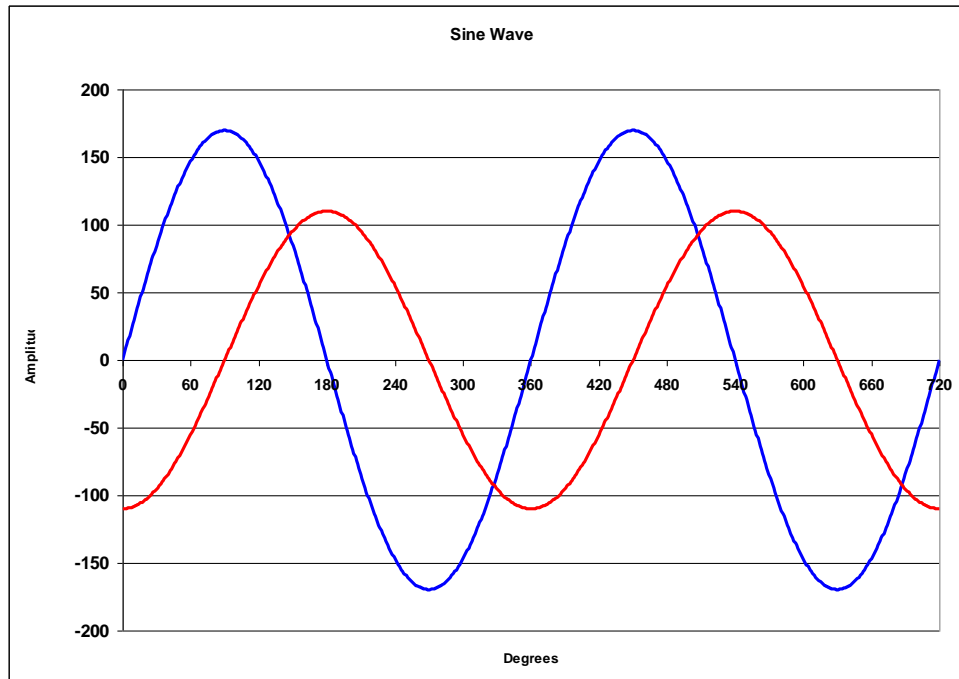

Inductors are measured in Henrys. When an AC voltage is applied to an inductor, the current is 90 degrees out of phase. We say the current “lags” the voltage. A inductive load is considered a “linear” load because when the voltage is sinusoidal the current is sinusoidal.



AC Theory – Capacitive Load

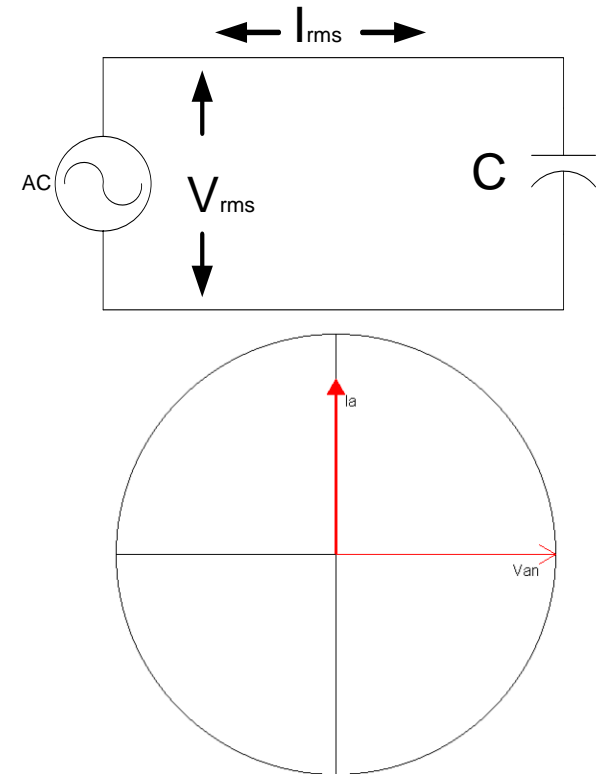
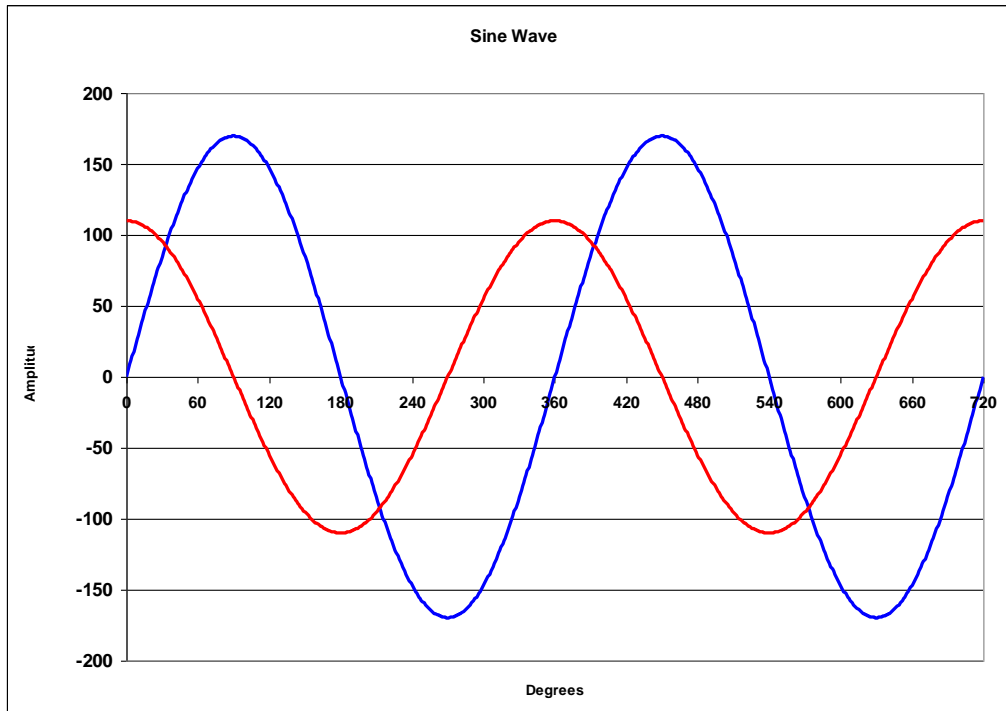

Capacitors are measured in Farads. When an AC voltage is applied to a capacitor, the current is 90 degrees out of phase. We say the current “leads” the voltage. A capacitive load is considered a “linear” load because when the voltage is sinusoidal the current is sinusoidal.



AC Theory – Active Power

- **Active Power** is defined as $P = VI$
- Power is a rate, i.e. Energy per unit time.
- The Watt is the unit for Power
 - 1 Watt = 1000 Joules/sec
- Since the voltage and current at every point in time for an AC signal is different, we have to distinguish between **instantaneous power** and **average power**.
- Generally when we say “power” we mean average power.



AC Theory – Energy

- Energy is power integrated over a period of time.
- The units of Energy are:
 - Watt-Hour (abbreviated Wh)
 - Kilowatt-Hour (abbreviated kWh)
- A Wh is the total energy consumed when a load draws one Watt for one hour.



AC Theory – Instantaneous Power

For a resistive load: $p = vi = 2VI \sin^2(\omega t) = VI(1 - \cos(2\omega t))$

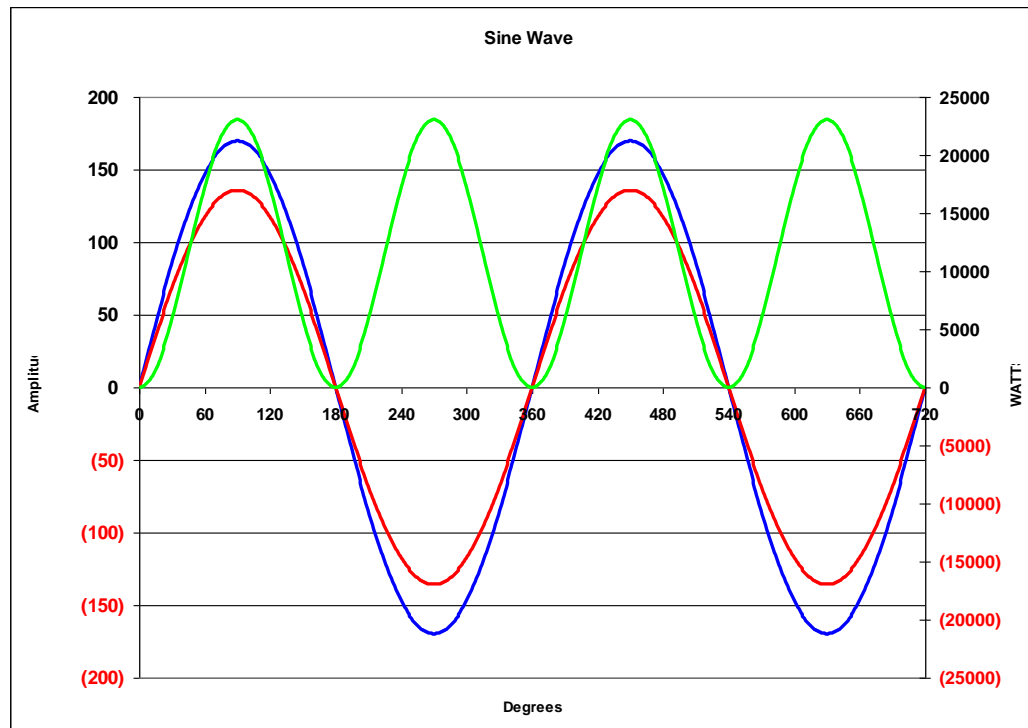

$$V = 120\sqrt{2} \sin(2\pi ft)$$

$$I = 96\sqrt{2} \sin(2\pi ft)$$

$$P = 23040 \sin^2(2\pi ft)$$

$$P = 11520 \text{ Watts}$$



AC Theory – Instantaneous Power

For an inductive load:

$$p = vi = 2VI \sin(\omega t) \sin(\omega t - 90) = -VI \sin(2\omega t)$$

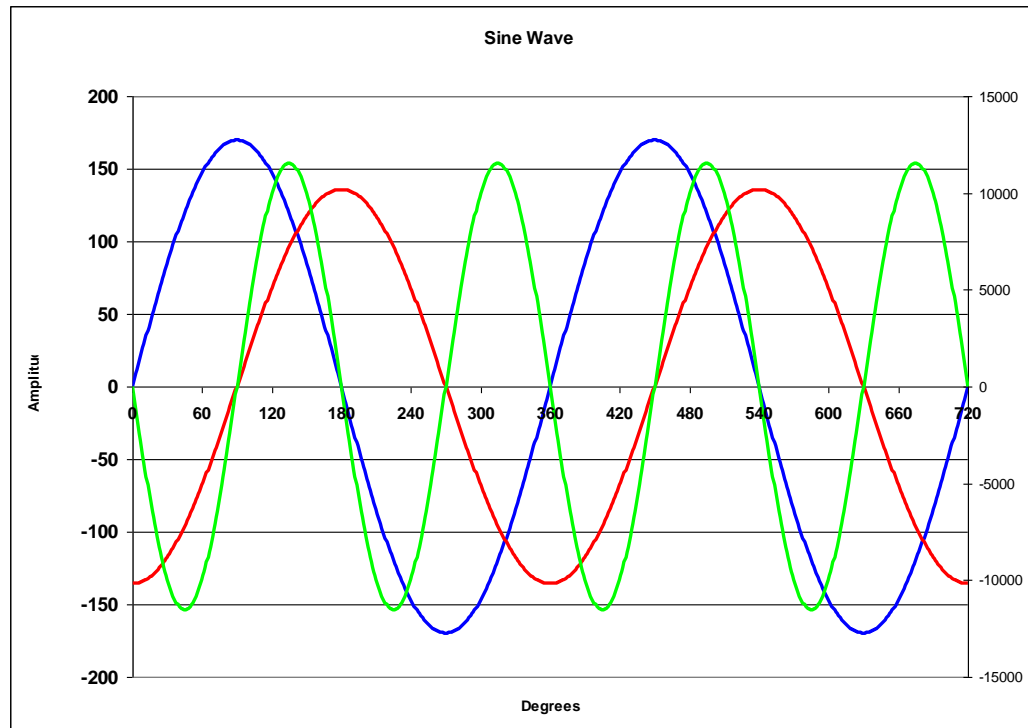

$$V = 120\sqrt{2} \sin(2\pi ft)$$

$$I = 96\sqrt{2} \sin(2\pi ft - 90)$$

$$P = -11520 \sin(2\pi ft)$$

P = 0 Watts



AC Theory – Instantaneous Power

For an capacitive load: $p = vi = 2VISin(\omega t)Sin(\omega t + 90) = VISin(2\omega t)$

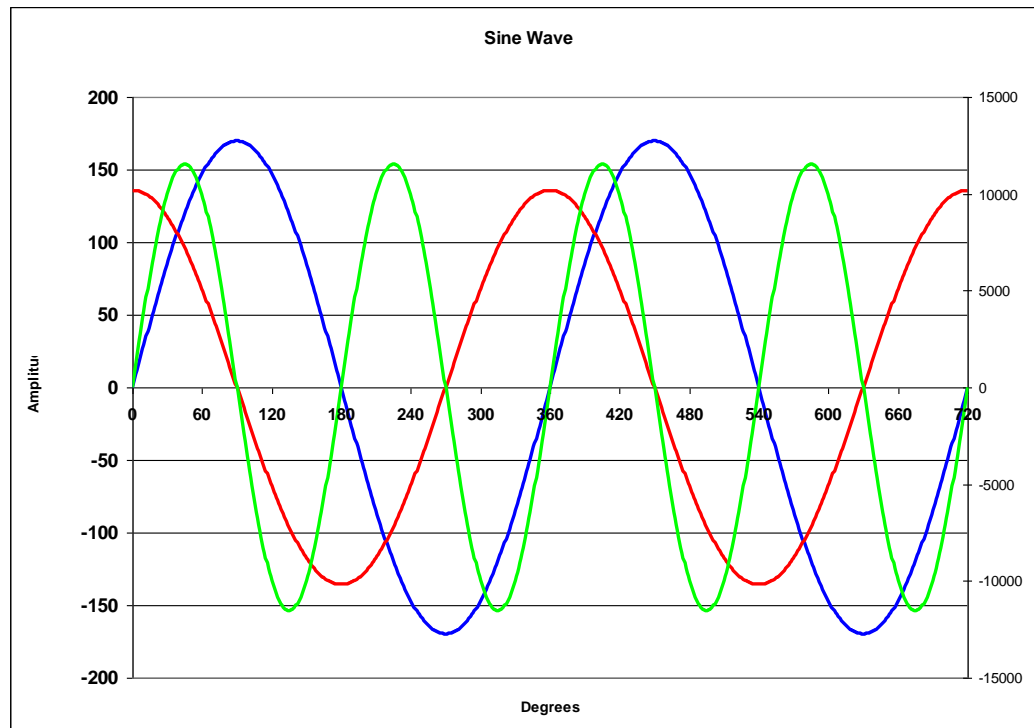

$$V = 120\sqrt{2} \sin(2\pi ft)$$

$$I = 96\sqrt{2} \sin(2\pi ft + 90)$$

$$P = 11520 \sin(2\pi ft)$$

$P = 0$ Watts



AC Theory – Complex Circuits

- Impedance – The equivalent to the concept of resistance for an AC circuit. It is also measured in Ohms. Designated by the symbol X .
- In AC circuits non-resistive impedance affects both the amplitude and phase of the current.
- A resistor R has an impedance which is frequency independent. There is no phase shift.
- An inductor has an impedance which is proportional the frequency, $X_L = 2\pi fL$. The phase is shifted by 90 degrees lagging.
- A capacitor has an impedance which is inversely proportional the frequency, $X_C = 1/2\pi fC$. The phase is shifted by 90 degrees leading.



AC Theory – Complex Circuits

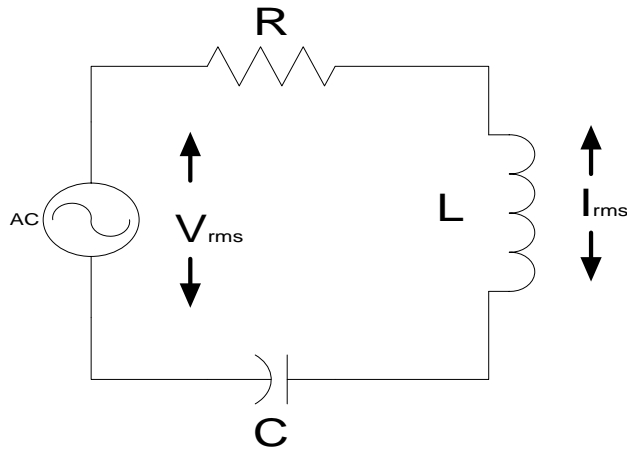

Amplitude (Current)

$$I = \frac{V}{\sqrt{R^2 + \left(\omega L - \frac{1}{\omega C}\right)^2}}$$

Phase (Current)

$$\varphi = \arctan \left[\frac{\left(\omega L - \frac{1}{\omega C}\right)}{R} \right]$$

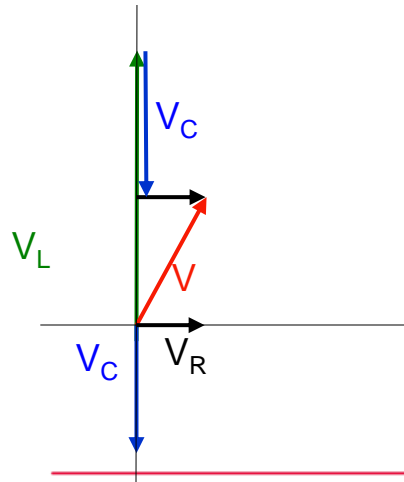

AC Theory – Instantaneous Power

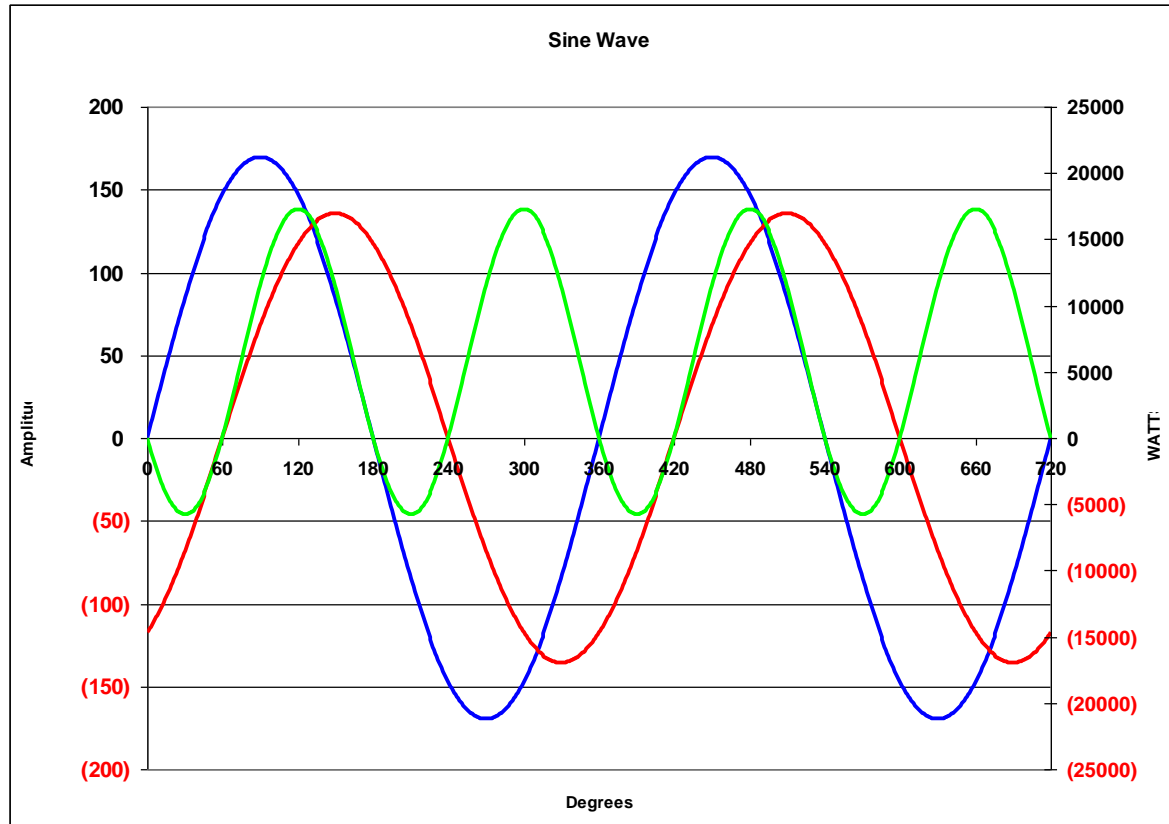

$$V = 120\sqrt{2} \sin(2\pi ft)$$

$$I = 96\sqrt{2} \sin(2\pi ft - 60)$$

$$P = VI = 23040(\cos(60^\circ) + \cos(4\pi ft - 60^\circ)) = 19953 - 23040 \cos(4\pi ft - 60^\circ)$$



Time Out for Trig

(Right Triangles)

The Right Triangle:

The Pythagorean theory

$$c^2 = a^2 + b^2$$

$$\sin(\theta) = \frac{b}{c}$$

$$\cos(\theta) = \frac{a}{c}$$

$$\tan(\theta) = \frac{b}{a}$$

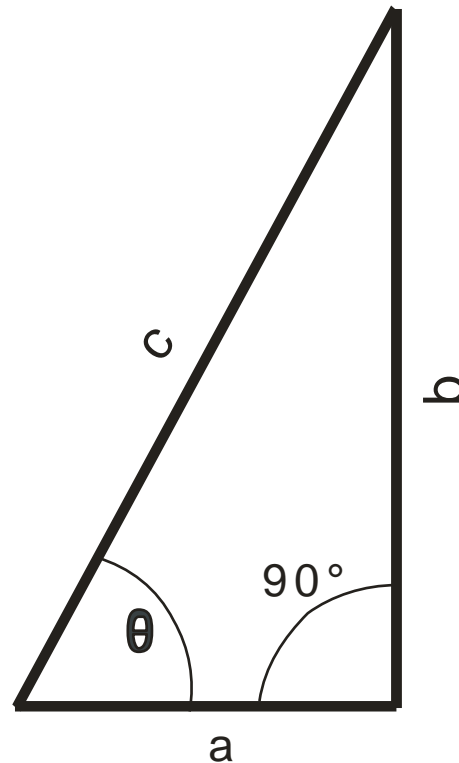

AC Theory – Power Triangle

(Sinusoidal Waveforms)

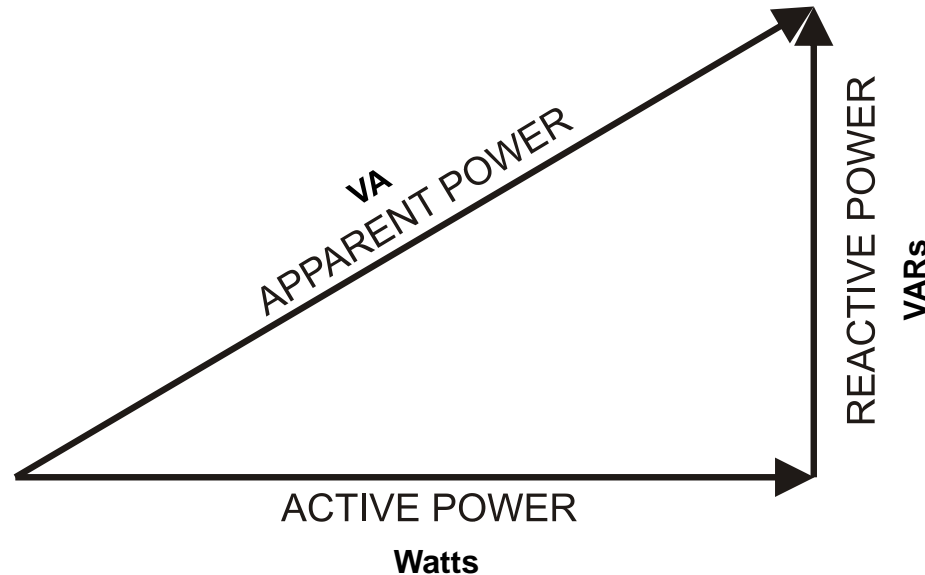

If $V = \sin(\omega t)$ and $I = \sin(\omega t - \theta)$ (and the load is linear)
then

$$\text{Active Power} = VI \cos(\theta) \quad \text{Watts}$$

$$\text{Reactive Power} = VI \sin(\theta) \quad \text{VARs}$$

$$\text{Apparent Power} = VI \quad \text{VA}$$

$$\text{Power Factor} = \frac{\text{Active}}{\text{Apparent}} = \cos(\theta)$$



Harmonics

Curse of the Modern World

- Every thing discussed so far was based on “Linear” loads.
 - For linear loads the current is always a simple sine wave. Everything we have discussed is true.
- For nearly a century after AC power was in use ALL loads were linear.
- Today, many loads are NON-LINEAR.



Harmonic Load Waveforms

ANSI C12.20 now addresses harmonic waveforms as well as sinusoidal.

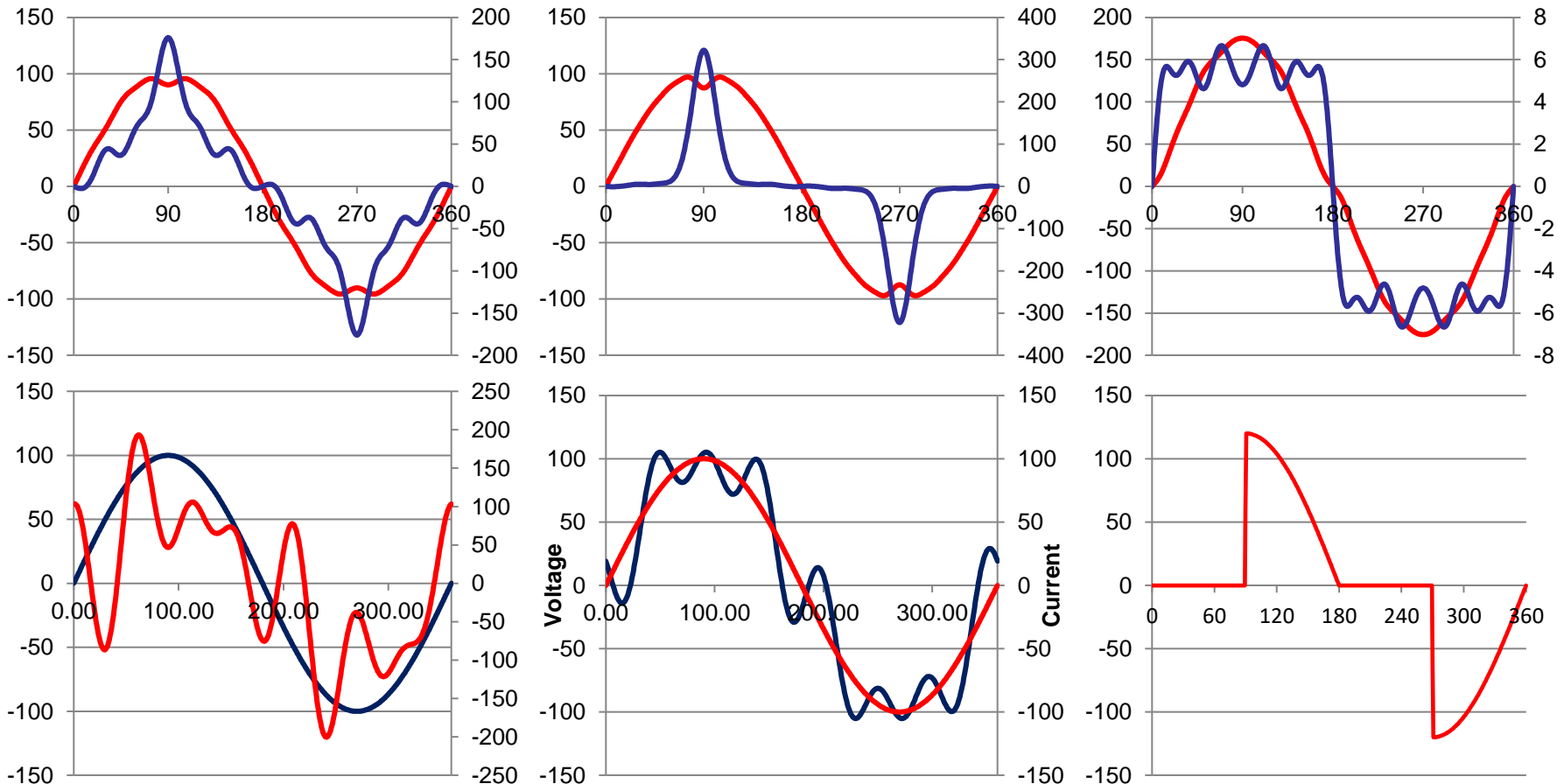

Test waveforms being proposed for ANSI C12.20.

Slide 30



AC Theory - Phasors

- An easier way to view AC data

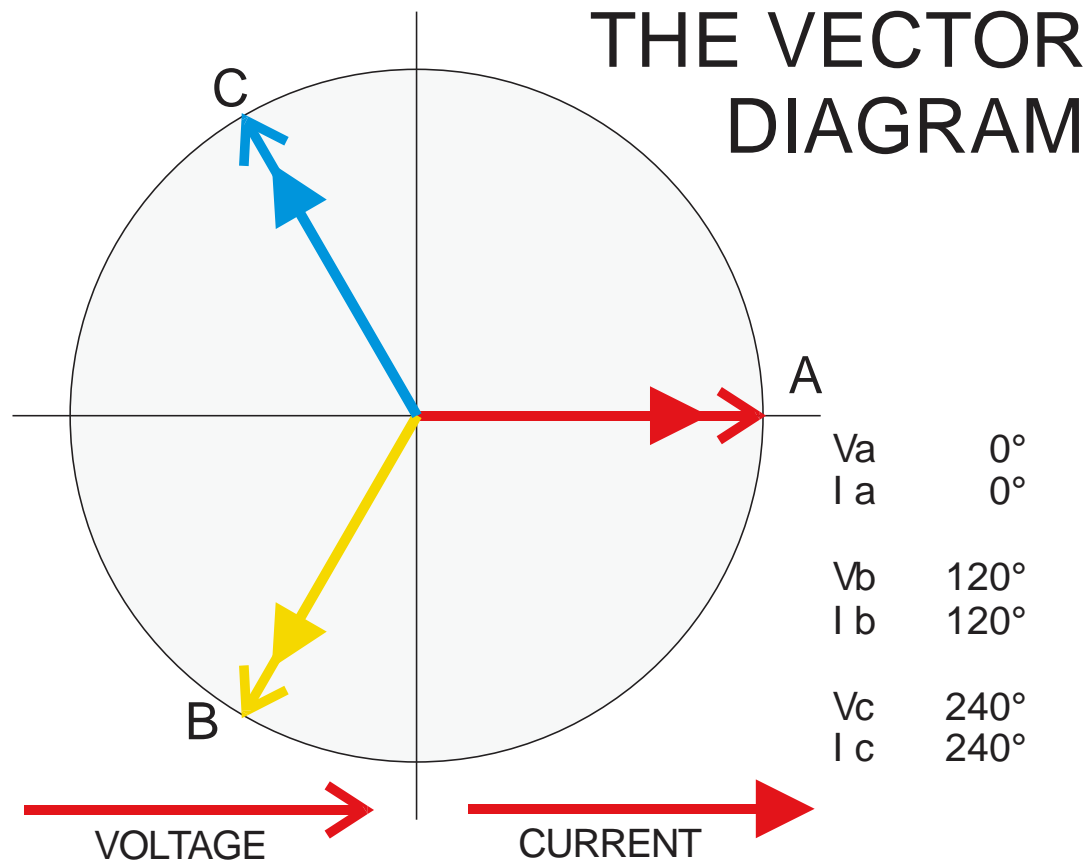

AC Theory - Phasors

- The length of the phasor is proportional to the value of the quantity
- The angle of the phasor (by convention phase A is drawn as horizontal) shows the phase of the quantity relative to phase A voltage.
- Here the current “lags” the voltage by 30 degrees.

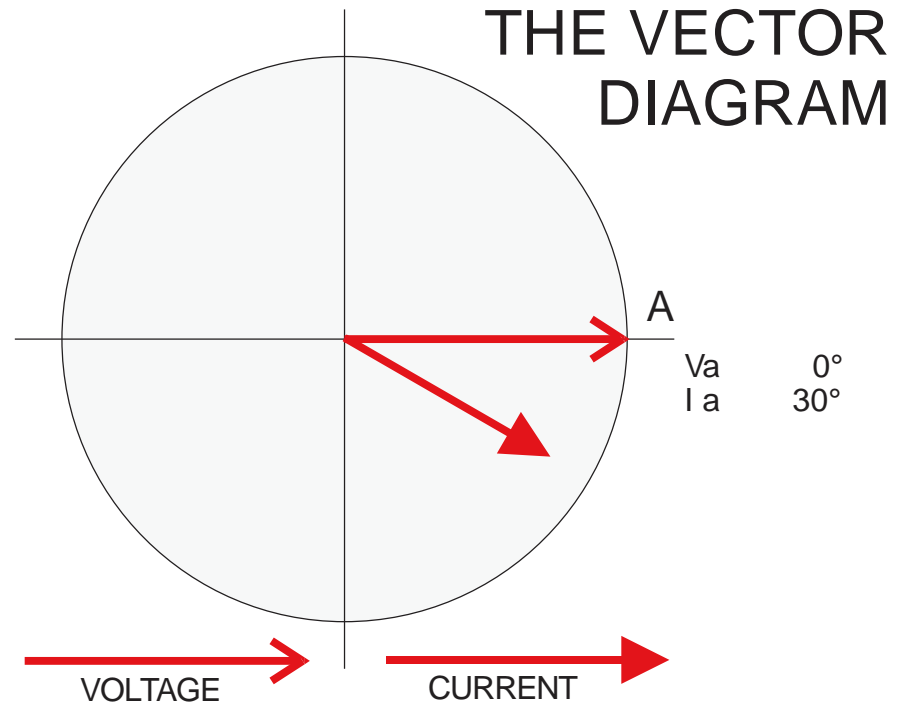

$$I = 2.5\sqrt{2} \sin(2\pi ft - 30)$$

$$V = 120\sqrt{2} \sin(2\pi ft - 0)$$



AC Theory - Phasors

Phasors are particularly useful in poly-phase situations

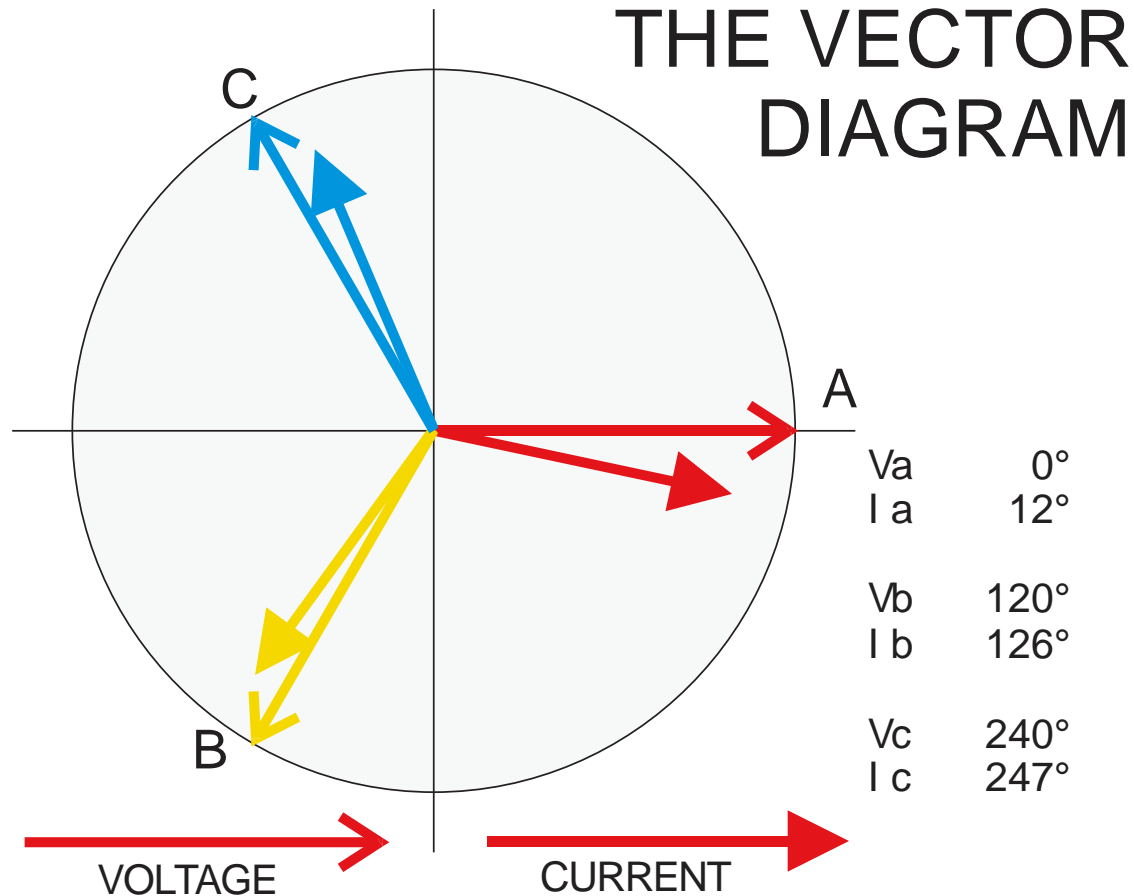

New Energy Definitions

- At the moment there is no non-sinusoidal definition for VA
- New ANSI Standard coming very soon

C12.31

American National Standard

**for Electricity Meters—
Measurement of VA and Power Factor**



New Definitions

RMS Voltage

Eq. 4.1.4.1 $V(t) = \frac{a_0}{2} + \sum_{n=1}^{\infty} (a_n \cos(n\omega_0 t) + b_n \sin(n\omega_0 t))$ Waveform

Eq. 4.2.4.1 $V = \frac{1}{T} \int_0^T V^2(t) dt$ Basic Definition

Eq. 4.2.4.2 $V = \sqrt{\frac{1}{N} \sum_n V_n^2}$ Time Domain

Eq. 4.2.4.3 $V = \frac{1}{\sqrt{2}} \left[\sum_n (a_{vn}^2 + b_{vn}^2) \right]^{1/2}$ Frequency Domain



New Definitions

RMS Current

Eq. 4.1.4.2
$$I(t) = \frac{c_0}{2} + \sum_{n=1}^{\infty} (c_n \cos(n\omega_0 t) + d_n \sin(n\omega_0 t))$$
 Waveform

Eq. 4.2.2.1
$$I = \frac{1}{T} \int_0^T I^2(t) dt$$
 Basic Definition

Eq. 4.2.2.2
$$I = \sqrt{\frac{1}{N} \sum_n I_n^2}$$
 Time Domain

Eq. 4.2.2.3
$$I = \frac{1}{\sqrt{2}} \left[\sum_n (c_{vn}^2 + d_{vn}^2) \right]^{1/2}$$
 Frequency Domain



New Definitions

Active Power

Eq. 4.2.3.1
$$P = \frac{1}{T} \int_0^T V(t)I(t)dt$$
 Basic Definition

Eq. 4.2.3.2
$$P = \frac{1}{N} \sum_{i=0}^{i=N-1} V_i I_i$$
 Time Domain

Eq. 4.2.3.3
$$P = \frac{1}{2} \sum_n |\vec{V}_n \bullet \vec{I}_n| = \frac{1}{2} \sum_n (a_n c_n + b_n d_v)$$

$$= \frac{1}{2} \sum_n V_n I_n \cos(\theta_n)$$
 Frequency Domain



New Definitions

Apparent Power

Eq. 4.2.3.1
$$S = \sqrt{\frac{1}{T} \int_0^T V^2(t) dt} \sqrt{\frac{1}{T} \int_0^T I^2(t) dt}$$
 Basic Definition

Eq. 4.2.3.2
$$S = VA = \sqrt{\frac{1}{N} \sum_{i=0}^{i=N-1} V_i^2} \cdot \frac{1}{N} \sum_{i=0}^{i=N-1} I_i^2$$
 Time Domain

Eq. 4.2.3.3
$$S = \frac{1}{2} \left[\sum_n (a_n^2 + b_n^2) \sum_n (c_n^2 + d_n^2) \right]^{1/2}$$
 Frequency Domain



Questions and Discussion



Bill Hardy, CTO

TESCO – The Eastern Specialty Company

Bristol, PA

865-279-1090 (cell)

215-785-2338 (office)

This presentation can also be found under Meter Conferences and Schools on the TESCO website:

www.tesco-advent.com

